



# Installation Guide

## ROQSTAR Managed Gigabit Ethernet Switch

<b>Part No</b>	<b>Description</b>
006-130-117	ROQSTAR Managed 2GE+8FE Gigabit Ethernet Switch M12
006-130-118	ROQSTAR Managed 2GE+8FE Gigabit Ethernet Switch M12 PoE
006-130-132	ROQSTAR Managed 10 Port Gigabit Ethernet Switch M12
006-130-133	ROQSTAR Managed 10 Port Gigabit Ethernet Switch M12 PoE

© 2023 TRONTEQ GmbH

All rights are reserved. The contents of this manual are protected by copyright. Their use is allowed as part of use of TRONTEQ GmbH products. Any other use which goes beyond in particular copying, reproduction, translation requires written consent of TRONTEQ GmbH.

TRONTEQ GmbH reserves the right to modify the contents of this manual. In addition, we refer to the conditions of use specified in the license agreement. The latest version of this manual is available online at [www.tronteq.com](http://www.tronteq.com).

# Content

- 1. Safety Instructions ..... 4**
  - 1.1. Information about this Operation Instructions ..... 4
  - 1.2. Warning Information System ..... 4
  - 1.3. Qualified Personnel ..... 4
  - 1.4. Intended Use ..... 4
  - 1.5. Liability Limitation ..... 4
  - 1.6. Recycling ..... 5
  
- 2. ROQSTAR Ethernet Switches ..... 6**
  - 2.1. Models Described in this MAnnual ..... 7
  - 2.2. Interfaces ..... 8
  
- 3. Installation ..... 9**
  - 3.1. Installation Guidelines ..... 9
  - 3.2. Power Port ..... 10
  - 3.3. Fast Ethernet Port ..... 10
  - 3.4. Gigabit Ethernet Port ..... 10
  - 3.5. USB Port ..... 10
  
- 4. Start Up and Operation ..... 11**
  - 4.1. Factory Settings ..... 11
  - 4.2. Configuration ..... 11
  - 4.3. PoE Model Operation ..... 11
  
- 5. LED ..... 12**
  - 5.1. System LED ..... 12
  - 5.2. Port LED ..... 12
  
- 6. Technical Data ..... 13**
  - 6.1. Electrical ..... 13
  - 6.2. Data Transfer ..... 14
  - 6.3. Startup Time ..... 14
  - 6.4. Mechanical ..... 14
  - 6.5. Environmental ..... 15
  - 6.6. MTBF ..... 15
  - 6.7. Standards and Approvals ..... 15
  
- 7. Order numbers ..... 16**
  
- 8. Contact ..... 16**
  - 8.1. Sales support ..... 16
  - 8.2. Technical support ..... 16

## 1. Safety Instructions

### 1.1. Information about this Operation Instructions

This operating instruction describes the application of the ROQSTAR Ethernet Switches. It allows the safe and efficient handling of the product. The operating instruction is a part of the device and must be available for the users at any time.

Before the beginning of any work the user has to read carefully and understand these instructions. The foundation for safe working is the compliance with all specified safety and handling instructions in this operating instruction. In addition, the local accident prevention regulations and general safety regulations apply for the handling with electrical energy and communications equipment.

The schemes and illustrations of this instruction are provided for basic understanding and may differ from the actual design.

### 1.2. Warning Information System

This manual contains notices you have to observe in order to ensure your personal safety, as well as to prevent damage to property. The notices referring to your personal safety are highlighted in the manual by a safety alert symbol, notices referring only to property damage have no safety alert symbol. These notices shown below are graded according to the degree of danger.



Indicates a potentially dangerous situation that **may** result in death or serious injury if it is not avoided.



Hint for useful tips and recommendations for efficient and trouble-free operation.

### 1.3. Qualified Personnel

The user must ensure that only qualified personnel will work with the device. The product described in this documentation may be operated only by personnel qualified for the specific task in accordance with the relevant documentation, in particular its warning notices and safety instructions. Qualified personnel are those who, based on their training and experience, are capable of identifying risks and avoiding potential hazards when working with these products.

### 1.4. Intended Use

Proper transport, storage, installation, assembly, commissioning, operation and maintenance are required to ensure that TRONTEQ products operate safely and without any problems. The permissible ambient conditions must be complied with. The information in the relevant documentation must be observed.

### 1.5. Liability Limitation

All information and instructions in this operating instruction has been compiled in accordance with current standards and regulations, state of the art as well as the knowledge and experience of the applications in the field. In the following cases the manufacturer is not liable for damages:

- ▶ Disregard of the operating instructions in this manual
- ▶ Improper use
- ▶ Employment of non-qualified personnel
- ▶ Unauthorized technical modification or reconstruction

The general terms and conditions are valid as well as the delivery terms of the manufacturer and the legal regulations which were taken when the contract was concluded.

We have reviewed the contents of this publication to ensure consistency with the hardware and software described. Since variance cannot be precluded entirely, we cannot guarantee full consistency. However, the information in this publication is reviewed regularly and any necessary corrections are included in subsequent editions.

## **1.6. Recycling**

After usage, this device must be disposed in accordance with the current disposal regulations as electronic waste.

## **2. ROQSTAR Ethernet Switches**

ROQSTAR Ethernet Switches are designed for use on public transport vehicles. They ensure the interconnection of Ethernet devices on an Ethernet network and facilitate the IP based communication for on board equipment of a public transport vehicle.

### **ROQSTAR Unmanaged**

These devices are characterized by their simplicity. The devices do not need to be configured and are immediately ready for operation after power up. They are mainly suitable for simple, smaller networks or serve as a local extension of the network.

### **ROQSTAR Expandable**

The expandable switches have the capability to be upgraded from unmanaged to managed Ethernet switch. They are initially delivered as unmanaged Ethernet Switches and can be upgraded to Managed Switches during operation by a software update.

### **ROQSTAR Managed**

These devices provide configuration and diagnostic capabilities for the network. They are suitable for larger and more complex networks. Typical use cases are IP address assignment, network segmentation, redundant communication, remote diagnostics, failure localization.

### **ROQSTAR PoE**

Power over Ethernet (PoE) makes it possible to provide power supply through data cable to the devices, that are connected to the Ethernet Switch. All ROQSTAR PoE devices have an integrated, isolated 24V power supply for PoE.

### **ROQSTAR Gigabit**

Devices with Gigabit Ethernet ports allow a data rate of up to 1000 Mbps. Gigabit speed is especially useful where large amounts of data are required. A good example is applications like CCTV. In addition, the larger data bandwidth is suitable for the backbone network. A Gigabit port can handle up to ten Fast Ethernet Ports (100Mbps) with a non-blocking data transfer.

## 2.1. Models Described in this Manual

- supported feature



Order No.	006-130-117	006-130-118	006-130-131	006-130-132
Type	Managed	Managed PoE	Managed	Managed PoE
Number of Gigabit Ethernet Ports	2	2	10	10
Gigabit Ethernet Connectors	M12 x-coded	M12 x-coded	M12 x-coded	M12 x-coded
Speed at Gigabit Ports	10/100/1000 Mbit/s	10/100/1000 Mbit/s	10/100/1000 Mbit/s	10/100/1000 Mbit/s
Number of Fast Ethernet Ports	8	8	-	-
Fast Ethernet Connectors	M12 d-coded	M12 d-coded	-	-
Speed at Fast Ethernet Ports	10/100 Mbit/s	10/100 Mbit/s	-	-
Power Supply	DC: 9.6...60 V	DC: 16...52 V	DC: 9.6...60 V	DC: 16...52 V
Power Supply Connector	M12 a-coded	M12 a-coded	M12 a-coded	M12 a-coded
Operating Temperature	-40° ... + 70°C	-40° ... + 70°C	-40° ... + 70°C	-40° ... + 70°C
PoE / PoE+ Ports	-	8	-	8
PoE Voltage / Total Power Budget	-	53V / 80W	-	53V / 80W
Boot time	< 20s	< 20s	< 20s	< 20s
auto negotiation, auto polarity, auto crossing	•	•	•	•
USB Interface for configuration and updates	•	•	•	•
Configuration via User Web Interface	•	•	•	•
QoS, VLAN, SNMP, LLDP, RSTP, DHCP sever/client, Port Mirroring,	•	•	•	•
Auto-Deployment, DHCP Filtering, USB API, ITxPT inventory module, Ignition Sleep Mode	•	•	•	•

## 2.2. Interfaces

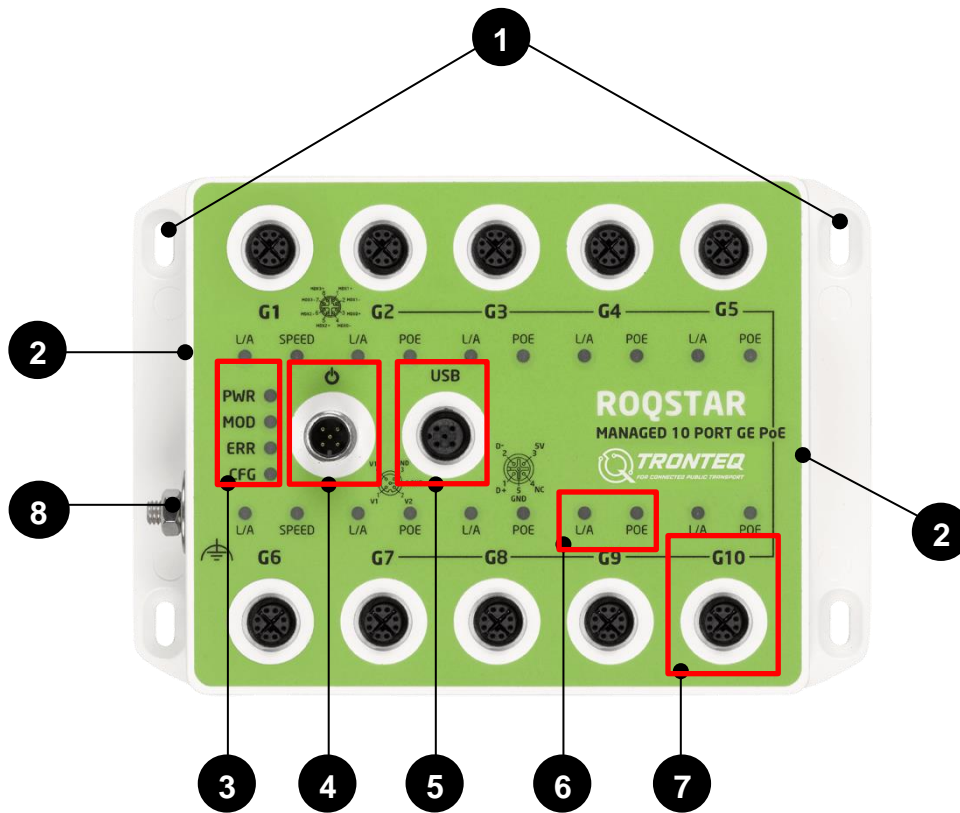

No	Description	No	Description
1	mounting holes	5	USB port
2	model label	6	port LED
3	status LED	7	Ethernet port
4	power port	8	ground terminal M6



### 3. Installation

	<p>Never perform wiring under voltage</p> <p>Do not perform any installation under voltage</p>
---	--

#### 3.1. Installation Guidelines

Follow the steps below to install the device

- ▶ For installation choose a location with a flat plane
- ▶ Prepare the drill holes at the installation location for the device mounting holes
- ▶ Make sure that all electrical connectors are volt-free
- ▶ Make sure that the device is disconnected from all connections
- ▶ Align the device on the prepared plane and fasten up with four screws
- ▶ Connect device to chassis through ground terminal M6
- ▶ Connect and fasten all cables

	<p>Recommended torque:</p> <ul style="list-style-type: none"><li>▶ Ground terminal M6: min. 1Nm / max. 3Nm</li><li>▶ M12 cables: min. 0,6Nm / max. 0,8Nm</li><li>▶ Protection caps: 0,6Nm</li></ul>
--	---

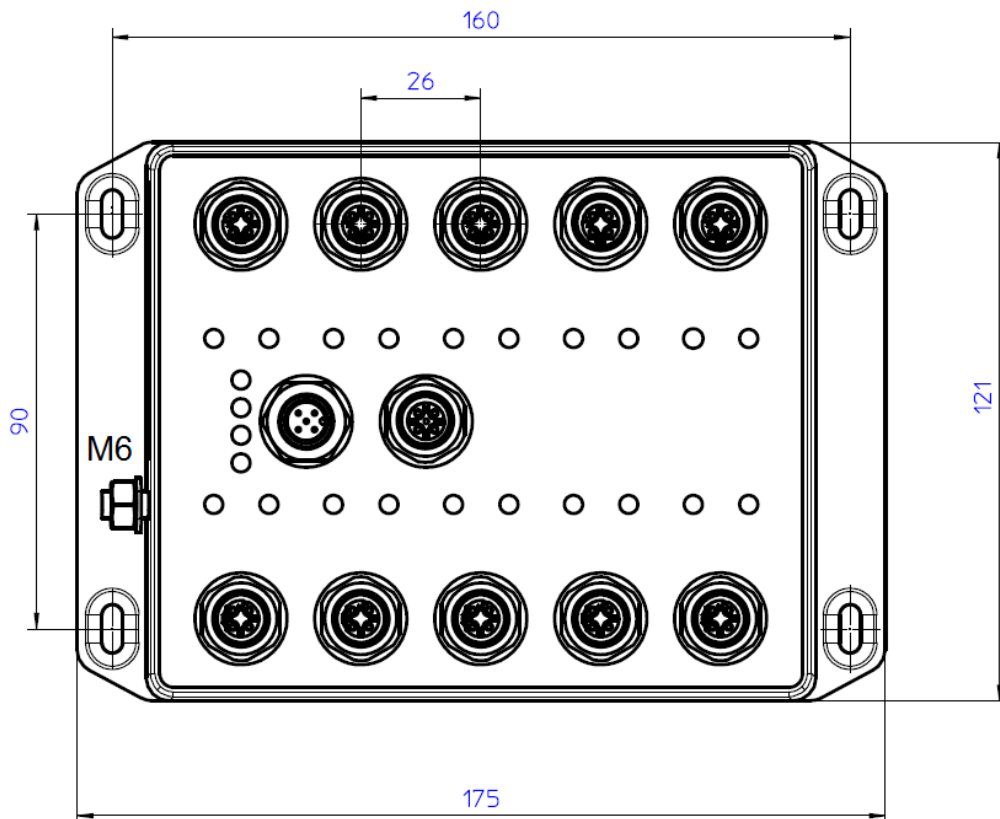

### 3.2. Power Port

The ROQSTAR device provides two power ports. For Ethernet Switch function apply power supply to V1 or V2. For PoE function the power supply must be applied to V1.

	<p>V1 supplies both, Ethernet and PoE function</p> <p>V2 supplies Ethernet function only</p>
---	--

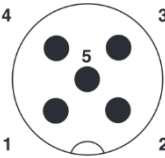
Connector type: M12 a-coded, 5 pins, male				
Pin	Name	Signal	Assignment	
1	V1	power supply 1, positive pole		
2	V2	power supply 2, positive pole, ignition signal		
3	GND	power supply, negative pole		
4	V1	power supply 1, positive pole		
5	GND	power supply, negative pole		

### 3.3. Fast Ethernet Port

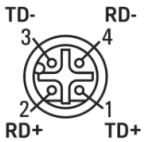
Connector type: M12 d-coded, 4 pins, female				
Pin	Name	Signal	PoE	Assignment
1	TD+	Transmit Data +	plus pole (+)	
2	RD+	Receive Data +	minus pole (-)	
3	TD-	Transmit Data -	plus pole (+)	
4	RD-	Receive Data -	minus pole (-)	

### 3.4. Gigabit Ethernet Port

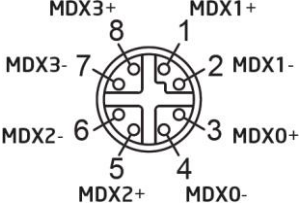
Connector type: M12 x-coded, 8 pins, female					
Pin	Name	Signal 10/100 Mbps	Signal 1000 Mbps	PoE function	Assignment
1	MDX1+	Receive Data +	BI_DB+	negative pole (-)	
2	MDX1-	Receive Data -	BI_DB-	negative pole (-)	
3	MDX0+	Transmit Data +	BI_DA+	positive pole (+)	
4	MDX0-	Transmit Data -	BI_DA-	positive pole (+)	
5	MDX2+	unused	BI_DC+		
6	MDX2-	unused	BI_DC-		
7	MDX3-	unused	BI_DD-		
8	MDX3+	unused	BI_DD+		

### 3.5. USB Port

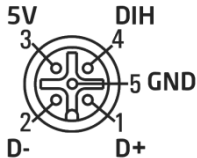
Connector type: M12 a-coded, 5 pins, female				
Pin	Name	Signal	Assignment	
1	D+	USB data, D+		
2	D-	USB data, D-		
3	5V	USB power supply, positive pole		
4	DIH	not connected		
5	GND	USB power supply, negative pole		

## 4. Start Up and Operation

A managed ROQSTAR model starts boot-up process after a valid supply voltage is applied. After boot-up process is finished, ROQSTAR Ethernet switch behaves according to configured settings. If no user configuration is saved or available, factory settings are loaded.

### 4.1. Factory Settings

- ▶ Web interface IP-Addresses: 192.168.1.1
- ▶ Web interface Subnet 255.255.255.0
- ▶ Web interface login: admin
- ▶ Web interface password: password
- ▶ Ethernet Ports enabled, auto-negotiation
- ▶ VLAN Management VID 1, all ports are untagged members
- ▶ VLAN Auto Configuration VID 3579, all ports are tagged members
- ▶ DHCP Client enabled
- ▶ DHCP Server disabled
- ▶ DHCP Filtering enabled
- ▶ ITxPT Inventory Service enabled
- ▶ RSTP enabled
- ▶ LLDP enabled
- ▶ PoE enabled
- ▶ USB API enabled
- ▶ Ignition Sleep Mode disabled

### 4.2. Configuration

Applying user configuration to the ROQSTAR Ethernet Switch can be done through:

- ▶ Manual settings via web interface
- ▶ Loading of configuration file via USB memory stick
- ▶ Loading of configuration file via API
- ▶ Loading of configuration file via Auto-Deployment

### 4.3. PoE Model Operation

After boot-up ROQSTAR Ethernet Switch detects, classifies and supplies PDs (powered devices) in compliance to IEEE802.3at.

The total PoE power output is limited and controlled by internal logic. The power limit per port is set according to user defined configuration. The power allocation is done per port in accordance to PoE port settings. The logic continuously measures and monitors power consumption per port. A PD can be dropped, if its power consumption exceeds allocated power limit or the consumption of all ports exceeds total power budget.

Total power budget is defined in 6 Technical Data.

## 5. LED



LED provides a quick diagnostic for the device and the network

### 5.1. System LED

Name	Color	Behavior	Description
PWR	-	off	power supply not connected or voltage level too low
	green	on	V1, V2 are both powered
	green	flashing	either V1 or V2 is powered
MOD	-	off	device is booting
	green	on	device is in operation
	green	flashing	USB action in process
ERR	-	off	normal operation
	red	flashing	error during last USB action or error during last boot-up
	red	on	internal system error
CFG	-	off	factory settings applied
	green	flashing	user settings applied but not saved
	green	on	user settings applied and saved

### 5.2. Port LED

Name	Color	Behavior	Description
L/A	-	off	link down
	green	on	link up
	green	flashing	data traffic
Speed	-	off	link speed 10 Mbit/s or 100 Mbit/s
	orange	on	link speed 1000 Mbit/s

Name	Color	Behavior	Description
PoE	-	off	PoE port not powered
	orange	on	PoE port powered
	orange	flashing	PoE port blocked
	orange	flashing all port	V1 not supplied or internal PoE error

## 6. Technical Data

### 6.1. Electrical

Power Port parameters, standard model	min.	typ.	Max.	Dimension
Operating voltage SELV	+9.6	+24	+60	VDC
Reverse polarity protection	- 60	-	-	VDC
Reset level	-	8.0	-	VDC
Current consumption, all port with data transfer V1 = 9.6V	-	-	650	mA
Peak inrush current <1ms	-	10 @ 9.6V	14 @ 60V	A
Power consumption, all port with data transfer			7.0	W
Immunity of power interruption	10	-	-	ms
Internal fuse	-	2	-	A

Power Port parameters, PoE model	min.	typ.	Max.	Dimension
Operating voltage SELV	+16	+24	+52	VDC
Reverse polarity protection	- 60	-	-	VDC
Reset level	-	10	-	VDC
Current consumption, PoE load = 80W V1 = 16V	-	-	6.5	A
Peak inrush current <1ms	-	10 @ 9.6V	14 @ 60V	A
Power consumption, PoE load = 80W V1 = 24V	-	-	100	W
PoE supply immunity of power interruption	-	0	-	ms
Internal fuse for PoE	-	8	-	A

Isolation	min.	typ.	max.	Dimension
Ethernet Port ↔ Ethernet Port	-	-	-	VDC
Ethernet Ports (PoE) ↔ Power Port	± 2250	-	-	VDC
Ethernet Ports ↔ Chassis (ground)	± 2250	-	-	VDC
Chassis (ground) ↔ Power Port	± 850	-	-	VDC

PoE parameters	min.	typ.	max.	Dimension
Voltage	52	53	54	VDC
Current limit PoE class 0/3	-	290	320	mA
Current limit PoE class 1	-	70	90	mA
Current limit PoE class 2	-	130	150	mA
Current limit PoE class 4	-	560	660	mA
Internal fuse per port	-	1500	-	mA
Total PoE output power budget	80	-	-	W

## 6.2. Data Transfer

Ethernet-Ports	min.	typ.	max.	Dimension
Switch architecture	Store-and-Forward			
Address table size	16000 MAC addresses			
Bitrate	-	10 / 100	-	Mbit/s
Output impedance	-	100	-	$\Omega$
Input impedance	-	100	-	$\Omega$
Latency at 90 % load at 10 or 100 Mbit/s (frame size 64 / 1518 Byte) at 1000 Mbit/s (frame size 64 / 1518 Bytes)	-	2.4 0.9		$\mu$ s $\mu$ s
Throughput unicast packets Frame size 64 – 1518 Byte	-	full wire speed	-	
Throughput multicast packets Frame size 64 – 1518 Byte	-	full wire speed	-	
Frame size management	64	-	1518	Byte
switching	64	-	10240	Byte

## 6.3. Startup Time

Model	min.	typ.	max.	Dimension
Managed	-	20	-	sec.

## 6.4. Mechanical

Parameter	typ.	Dimension
Dimension (H x B x T, $\pm$ 0,5 mm)	121 x 175 x 52	mm
Mass standard type, net	550	g
Mass PoE type, net	790	g
Protection Class	IP54	-
Mounting	4x 4.8mm	-

## 6.5. Environmental

Parameter	min.	typ.	max.	Dimension
Ambient operating temperature	-40	-	+70	°C
Storage temperature	-40	-	+85	°C
Operating humidity (non-condensing)	10	-	95	%
Air pressure	700 (3000m)	-	-	hPa

## 6.6. MTBF

Model	25°C	60°C	Dimension
006-130-117	901 789	337 103	h
006-130-118	729 505	273 505	h
006-130-132	901 789	337 103	h
006-130-133	729 505	273 505	h

## 6.7. Standards and Approvals

The device complies with the following testing standards:

- ▶ Electromagnetic Radiation:
  - ▶ EN61000-6-4
  - ▶ EN55022: Class A
  - ▶ FCC47 CFR Part 15 Class A
  
- ▶ Immunity against conducted interference and external fields:
  - ▶ EN61000-6-2
  - ▶ EN61000-4-2
  - ▶ EN61000-4-3
  - ▶ EN61000-4-4
  - ▶ EN61000-4-5
  - ▶ EN61000-4-6
  
- ▶ Specific applications
  - ▶ EN50155
  - ▶ EN50121-4
  - ▶ EN61131-2
  - ▶ UNECE (E1) R10
  - ▶ UNECE (E1) R118
  - ▶ ITxPT Label

## 7. Order numbers

Order No.	Description
006-130-117	ROQSTAR Managed 2GE+8FE Gigabit Ethernet Switch M12
006-130-118	ROQSTAR Managed 2GE+8FE Gigabit Ethernet Switch M12 PoE
006-130-132	ROQSTAR Managed 10 Port Gigabit Ethernet Switch M12
006-130-133	ROQSTAR Managed 10 Port Gigabit Ethernet Switch M12 PoE

## 8. Contact

### 8.1. Sales support

Please contact our sales team at [sales@tronteq.com](mailto:sales@tronteq.com) for further inquiries and questions regarding our products.

### 8.2. Technical support

Please contact our support team at [support@tronteq.com](mailto:support@tronteq.com) if you have any technical questions or if you need technical training.

**TRONTEQ GmbH**

HOELZLESTR. 3  
72768 REUTLINGEN  
GERMANY

[www.tronteq.com](http://www.tronteq.com)